

ACCU ELECTRIC MOTORS INC

USA: (888) 932-9183

CANADA: (905) 829-2505

- ✓ Over 100 years cumulative experience
- ✓ 24 hour rush turnaround / technical support service
- ✓ Established in 1993



The leading independent repairer of servo motors and drives in North America.

Visit us on the web:

www.servo-repair.com

www.servorepair.ca

www.ferrocontrol.com

www.sandvikrepair.com

www.accuelectric.com

Scroll down to view your document!

For 24/7 repair services :

USA: 1 (888) 932 - 9183

Canada: 1 (905) 829 -2505

Emergency After hours: 1 (416) 624 0386

Servicing USA and Canada

BERGER LAHR

Catalogue

Servomotors

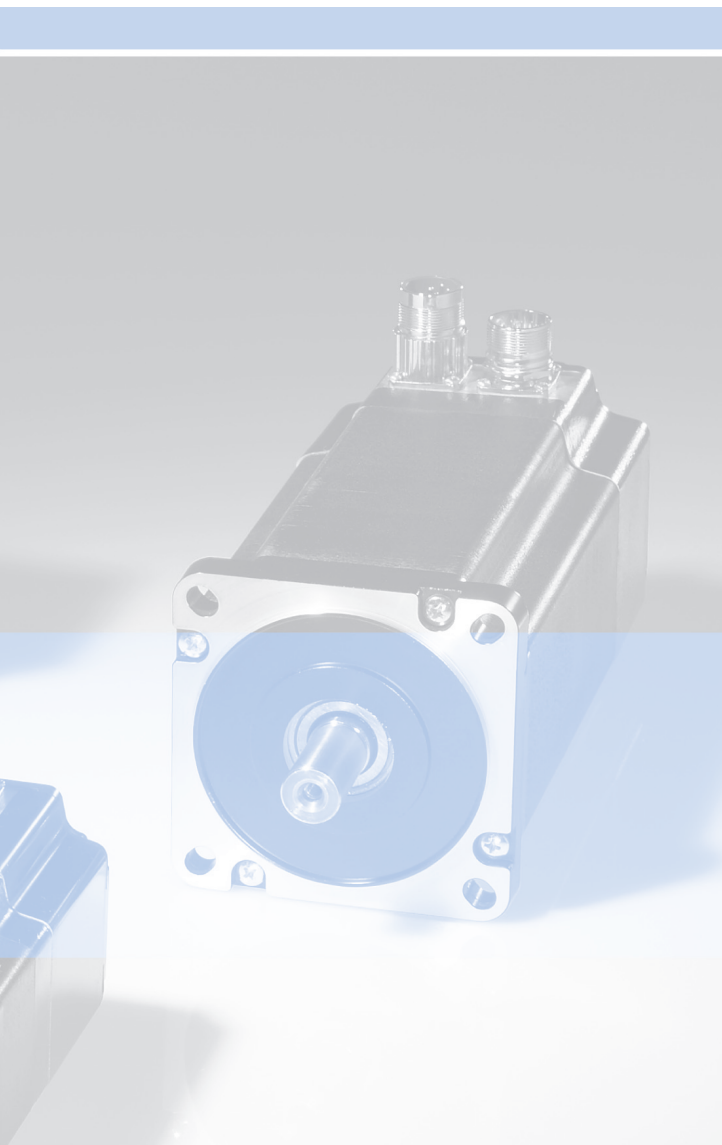

a company of
Schneider
Electric

SER servomotors

Product description 2

SER 36•

 Technical data 4

 Dimensional drawings 7

 Type code 8

SER 39•

 Technical data 9

 Dimensional drawings 12

 Type code 13

SER 311•

 Technical data 14

 Dimensional drawings 17

 Type code 18

Options

Holding brake 20

Position capture 21

Gearing for SER servomotors 23

Appendix

Conversion tables 27

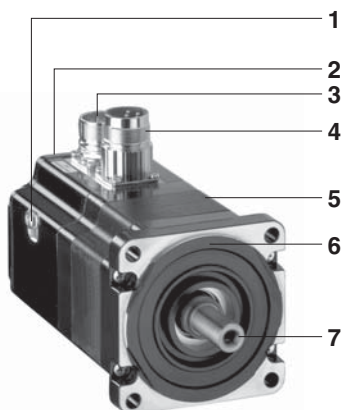
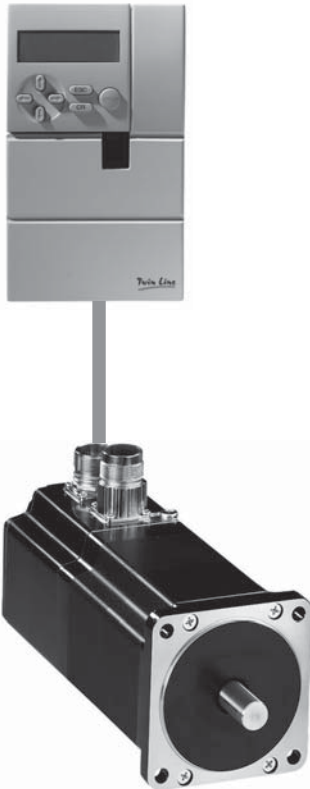

Product description

SER servomotors are AC synchronous servomotors and are fitted with permanent neodymium-iron-boron magnets (NdFeB). SER servomotors have a high power density and speed dynamics.

Thermal protection is provided by an integral probe in the motor. These motors support high overloads without risk of demagnetisation.

SER servomotors have been certified as "Recognised" (UR) by Underwriter Laboratories. They are compliant with the UL1004 standards and with European directives (CE mark).

Depending on the model, SER servomotors can be equipped with a holding brake and/or gearing.

The SER servomotors are compatible with the standard servo connection dimensions for flexible solutions for problems. The SER servomotors are fitted with the absolute sensor system as standard equipment. When using the HIPERFACE® interface between motor-sensor system and device the motor and current controller parameters are internally initialised. This greatly simplifies the commissioning procedure.

An AC synchronous servomotor module consists of the AC synchronous servomotor and the associated controller. Optimum power can only be reached when motor and controller are optimally matched.

Special features

High power density

The use of the latest magnetic materials and optimised design results in motors with a shorter length for comparable torque.

High pulse torques

Up to four times the continuous standstill torque.

Economical

With a strong standard series we can offer a compact and powerful AC synchronous servomotor.

Structure

SER servomotors with a 3-phase stator and an 8-pole (SER 36*: 6-pole) rotor with permanent NdFeB magnets have the following structure :

- (1) Additional terminal for protective conductor (not with SER 36*)
- (2) Nameplate
- (3) Screw connector for power cable connection
- (4) Screw connector for encoder cable connection
- (5) Housing with a square cross-section, with a black opaque polyester resin protective coating (RAL 2005).
- (6) Axial flange with four mounting points as per DIN 42948
- (7) Shaft end as per DIN 42948

Product overview

SER servomotors		SER 36•	SER 39•	SER 311•
				
Size (flange dimension)		6 (57.2 mm)	9 (85 mm)	11 (110 mm)
Nominal power P _N	kW	0.28 ... 0.62	0.30 ... 1.06	0.42 ... 2.09
Nominal speed n _N	1/min	3700 ... 12000	1200 ... 6000	1000 ... 6000
Nominal continuous torque M _N	Nm	0.26 ... 0.78	0.6 ... 2.8	1.5 ... 10.8
Continuous torque M ₀	Nm	0.29 ... 0.90	1.1 ... 3.6	4.2 ... 13.4
Max. torque M _{max}	Nm	1.03 ... 3.74	3.43 ... 12.67	11.76 ... 40.20

Motor types

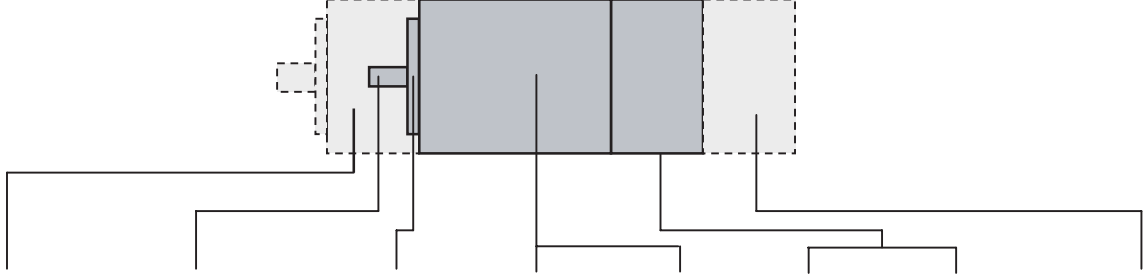

Gearing ¹⁾	Shaft model	Centring collar	Size (Flange dimension)	Length (Dimension without shaft)	Winding ²⁾	Max. voltage	Options
SER 36•							
PLE 60	Smooth with parallel key	Ø 9 mm	Ø 40 mm	4 (126 mm)	3S	230 V _{AC} / 325 V _{DC}	Holding brake Position capture ³⁾ Plug connector ⁴⁾
PLS 70				6 (145 mm)	5S		
				8 (163 mm) 10 (182 mm)	7S		
SER 39•							
PLE 80	Smooth with parallel key	Ø 14 mm	Ø 50 mm	7 (141 mm)	3S	480 V _{AC} / 680 V _{DC}	Holding brake Position capture ³⁾ Plug connector ⁴⁾
PLE 120				10 (171 mm)	5S		
PLS 70				13 (201 mm)	7S		
PLS 90 PLS 115				16 (231 mm)			
SER 311•							
PLE 120	Smooth with parallel key	Ø 19 mm	Ø 56 mm	12 (132 mm)	3S	480 V _{AC} / 680 V _{DC}	Holding brake Position capture ³⁾ Plug connector ⁴⁾
PLE 160				17 (180 mm)	5S		
PLS 90				22 (228 mm)	7S		
PLS 115 PLS 142				27 (276 mm)	5D		

¹⁾ Planetary gear available in the gear ratios 3:1, 5:1 and 8:1
²⁾ Winding types: S = star; D = delta
³⁾ Types: Singleturn encoder SinCos (SRS), Multiturn encoder SinCos (SRM) or resolver
⁴⁾ Type 1: straight; type 2: 90° angle and rotatable 310°

Note: For combination options see type code

SER 36•

Technical Data

Motor type	SER 364			SER 366			SER 368			SER 3610						
	3S	5S	7S	3S	5S	7S	3S	5S	7S	3S	5S	7S				
Winding ¹⁾																
Nominal supply voltage $U_N = 230 V_{AC}$																
• Nominal continuous torque M_N	Nm	0.26	0.27	0.28	0.44	0.46	0.49	0.48	0.55	0.65	0.5	0.62	0.78			
• Nominal continuous current I_N	A_{rms}	1.8	1.2	0.95	2.3	1.5	1.2	2.0	1.6	1.0	2.1	1.6	1.1			
• Nominal speed n_N	1/min	12000	10000	8000	12000	9000	6000	12000	8500	4300	12000	8000	3700			
• Nominal power P_N	kW	0.32	0.28	0.23	0.55	0.43	0.30	0.60	0.49	0.29	0.62	0.51	0.30			
Continuous torque M_0 ²⁾	Nm	0.29			0.54			0.75			0.9					
Continuous current I_0	A_{rms}	2.0	1.3	1.0	2.75	1.8	1.25	3.05	2.1	1.15	3.53	2.3	1.2			
Voltage constant k_{EU_V} ³⁾	V_{rms}	9.1	13.5	18.0	12.0	18.2	26.4	14.9	21.7	39.0	15.4	23.8	46.4			
Winding resistance R_W	Ω	4.7	11.1	18.9	3.7	9.1	17.4	3.4	7.3	23.7	2.7	6.1	23.0			
Winding inductance L_{qU_V}	mH	9.2	21.8	37.9	7.9	21.0	37.5	7.6	15.9	53.0	6.0	14.0	54.0			
Winding inductance L_{dU_V}	mH	7.9	19.2	33.4	7.1	18.6	32.9	6.7	14.0	46.7	5.2	12.5	47.0			
Maximum values																
Max. winding voltage U_{max}	V_{AC}	230			230			230			230					
	V_{DC}	325			325			325			325					
Max. voltage against PE	V_{AC}	300			300			300			300					
Max. current I_{max} ⁴⁾	A_{rms}	10.4	6.5	5.2	12.3	8.0	5.6	14.5	10.0	5.5	17.5	11.5	6.0			
Max. torque M_{max}	Nm	1.04	1.07	1.03	1.90	1.82	1.90	2.80	2.80	2.80	3.74	3.69	3.65			
Max. allowable speed of rotation n_{max}	1/min	12000			12000			12000			12000					
Max. continuous power P_{dmax}	kW	0.326			0.553			0.603			0.628					
Torque at max. continuous power M_{Pdmax}	Nm	0.28			0.44			0.48			0.5					
Speed of rotation at max. continuous power n_{Pdmax}	1/min	12000			12000			12000			12000					
Mechanical values																
Rotor moment of inertia J_R	$kgcm^2$	0.1			0.18			0.26			0.34					
Mass m ⁵⁾	kg	1.1			1.4			1.7			2.0					
Shaft load ⁶⁾																
• Max. radial force front F_R	N	- 10% ED			231			275			302			320		
		- 100% ED			89			107			117			124		
• Max. axial force tension/compression F_A	N	- 10% ED			300			300			300			300		
		- 100% ED			104			104			104			104		
• Nominal bearing lifetime L_{10h}	h	20000														

¹⁾ Definition of winding see type code

²⁾ At 20 1/min; for $n = 0$ max. 89%

³⁾ RMS value at 1000 1/min

⁴⁾ Max. 2.5 s

⁵⁾ Without holding brake

⁶⁾ Axial and radial forces must not occur simultaneously

Characteristic curves

SER 364 / 3L 3S

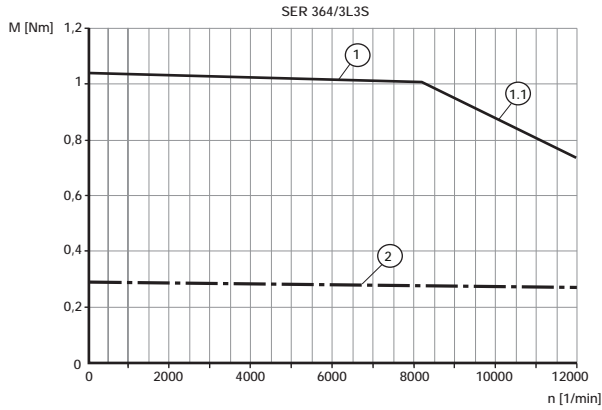

SER 364 / 3L 5S

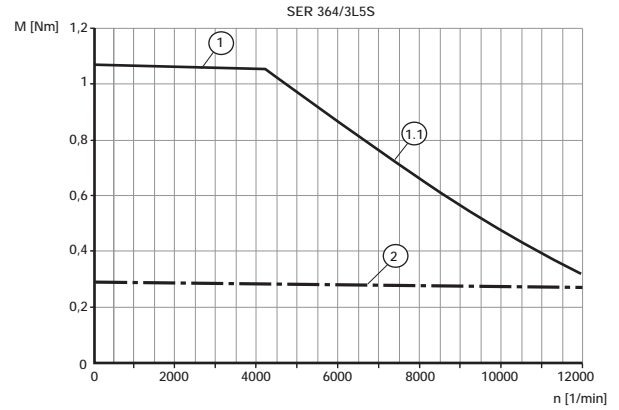

SER 364 / 3L 7S



SER 366 / 3L 3S

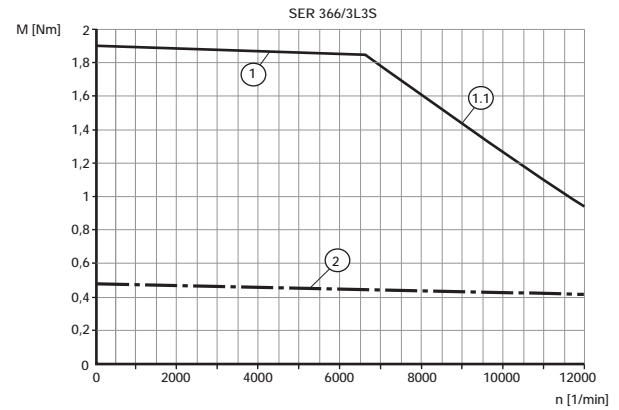

SER 366 / 3L 5S

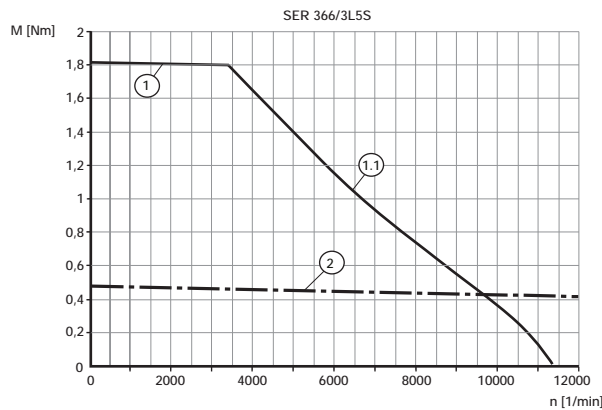

SER 366 / 3L 7S

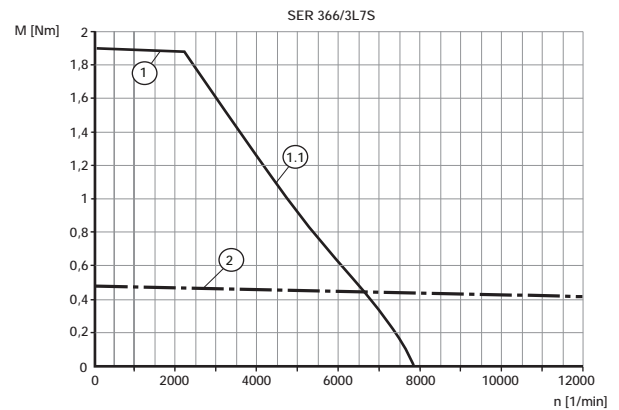

- (1) Peak torque of motor
- (1.1) Speed limit at 230 V_{eff}
- (2) Continuous torque of motor

Note: The peak torque characteristics show the maximum values of the motors. The peak characteristics of the motors in combination with servo drive systems can be found at: www.berger-lahr.de > Downloads > Documentations > Motors.

Characteristic curves

SER 368 / 3L 3S

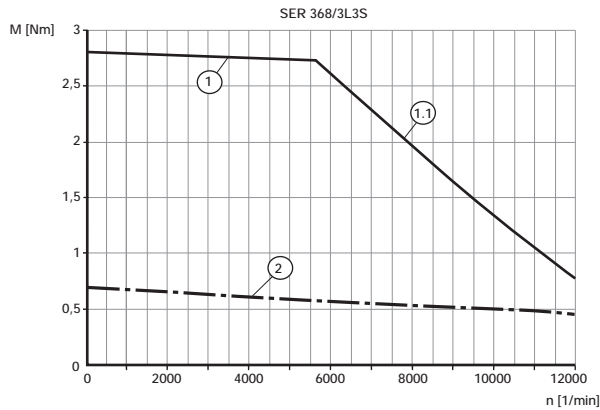

SER 368 / 3L 5S

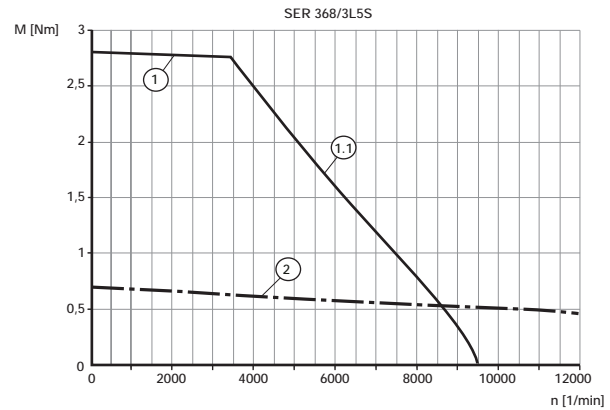

SER 368 / 3L 7S

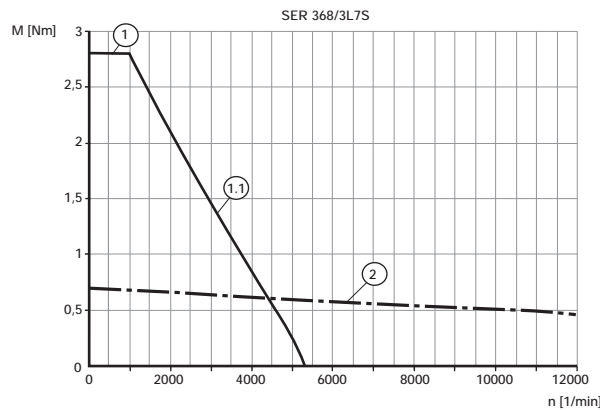

SER 3610 / 3L 3S

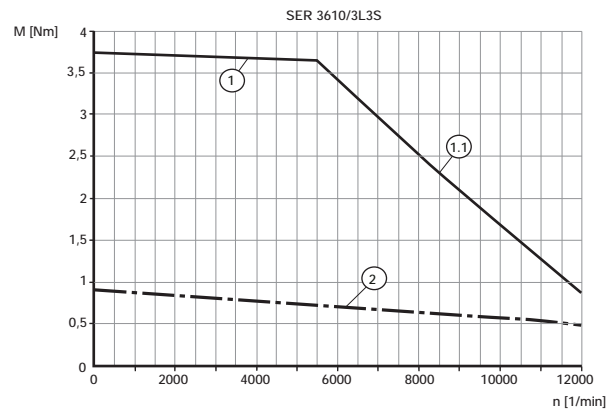

SER 3610 / 3L 5S

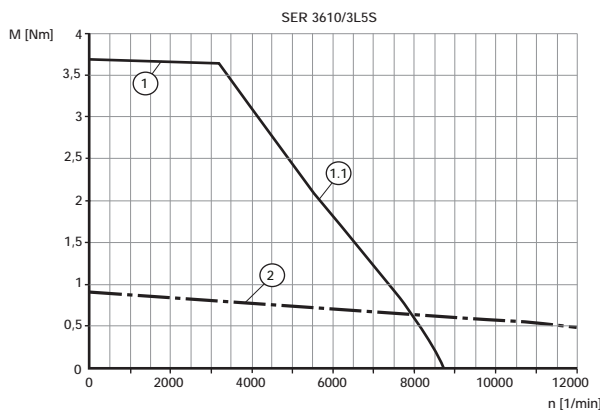

SER 3610 / 3L 7S

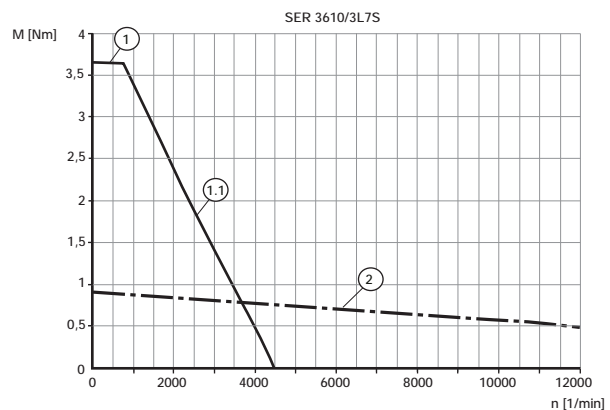

- (1) Peak torque of motor
- (1.1) Speed limit at 230 V_{eff}
- (2) Continuous torque of motor

Note: The peak torque characteristics show the maximum values of the motors. The peak characteristics of the motors in combination with servo drive systems can be found at: www.berger-lahr.de > Downloads > Documentations > Motors.

Ambient conditions		
Operating / ambient temperature without power reduction	°C	20 ... 40
Installation height without power reduction	m above MSL	1000
Transport and storage temperature	°C	-25 ... +70
Relative humidity	%	15 ... 85 (non-condensing)
Vibration magnitude in operation as per DIN EN 60034-14		A
Vibration strain as per DIN EN 60068-2-6		
• Acceleration amplitude	m/s ²	20
• Frequency range	Hz	10 ... 500
• Number of cycles		10
Degree of protection as per DIN EN 60034-5		
• Shaft exit front without shaft seal ring		IP 41
• Shaft exit front with shaft seal ring		IP 56 ¹⁾
• Motor housing		IP 56
Thermal class as per DIN EN 60034-1		155 (F)
Shaft wobble and run-out accuracy		as per DIN 42955 N (IEC 60072-1)
Max. rotary acceleration	rad/s ²	200000

¹⁾ Speed restriction by shaft seal ring at 6000 1/min; with mounting position IM V3 (drive shaft vertical, shaft end up) only degree of protection IP 41 is guaranteed.

Dimensional drawings

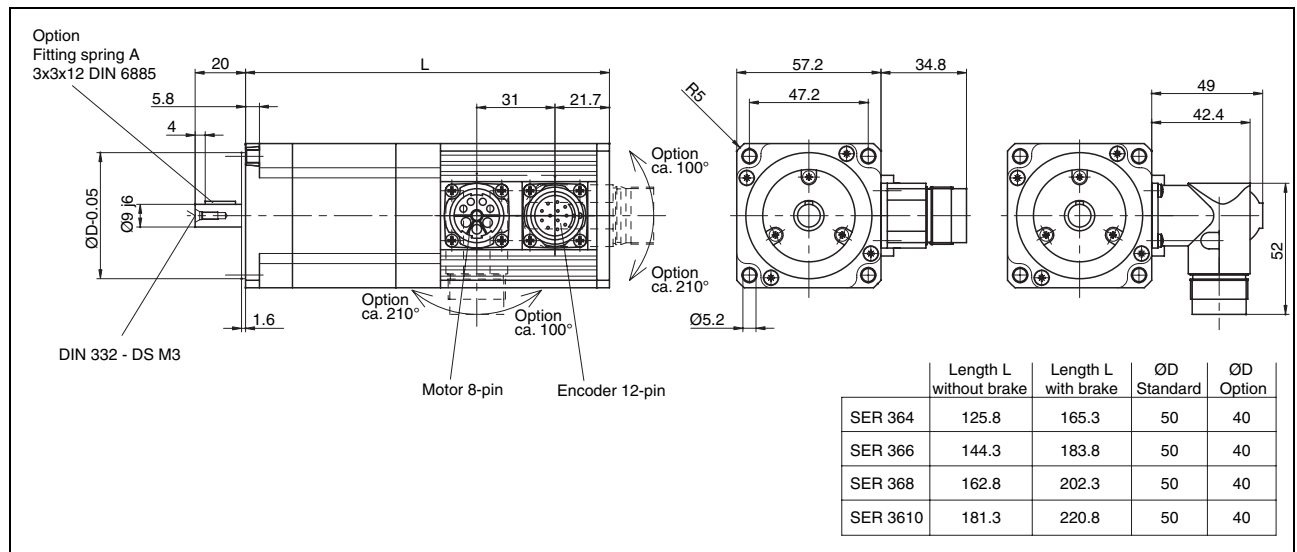

Dimensional drawing SER 36•

Type code																			
Example:	SER	3	6	4	/	3	L	3	S	M	O	T	O	IP41	2	3	K	50	PTC
Number of phases 3	SER	3	6	4	/	3	L	3	S	M	O	T	O	IP41	2	3	K	50	PTC
Size (flange) 6 = 57.2 mm	SER	3	6	4	/	3	L	3	S	M	O	T	O	IP41	2	3	K	50	PTC
Length 4 = 126 mm 6 = 145 mm 8 = 163 mm 10 = 182 mm	SER	3	6	4	/	3	L	3	S	M	O	T	O	IP41	2	3	K	50	PTC
Number of pole pairs 3	SER	3	6	4	/	3	L	3	S	M	O	T	O	IP41	2	3	K	50	PTC
Rotor inertia L = low moment of inertia	SER	3	6	4	/	3	L	3	S	M	O	T	O	IP41	2	3	K	50	PTC
Winding label 3; 5; 7	SER	3	6	4	/	3	L	3	S	M	O	T	O	IP41	2	3	K	50	PTC
Winding circuit S = star	SER	3	6	4	/	3	L	3	S	M	O	T	O	IP41	2	3	K	50	PTC
Sensor system S = SinCos Singleturn M = SinCos Multiturn R = resolver	SER	3	6	4	/	3	L	3	S	M	O	T	O	IP41	2	3	K	50	PTC
Sensor system resolution 0 for sensor systems S, M, R	SER	3	6	4	/	3	L	3	S	M	O	T	O	IP41	2	3	K	50	PTC
Plug connector C = straight T = 90° angled	SER	3	6	4	/	3	L	3	S	M	O	T	O	IP41	2	3	K	50	PTC
Holding brake O = without brake B = with brake	SER	3	6	4	/	3	L	3	S	M	O	T	O	IP41	2	3	K	50	PTC
Degree of protection IP41 = without shaft seal ring IP56 = with shaft seal ring ¹⁾	SER	3	6	4	/	3	L	3	S	M	O	T	O	IP41	2	3	K	50	PTC
Gearbox type ²⁾ 2 = PLE 60 A = PLS 70	SER	3	6	4	/	3	L	3	S	M	O	T	O	IP41	2	3	K	50	PTC
Gear ratio 3 = 3:1 5 = 5:1 8 = 8:1	SER	3	6	4	/	3	L	3	S	M	O	T	O	IP41	2	3	K	50	PTC
Motor shaft model K = parallel key DIN 6885 O = without parallel key / without gearing	SER	3	6	4	/	3	L	3	S	M	O	T	O	IP41	2	3	K	50	PTC
Centring collar 50 = 50 mm 40 = 40 mm 00 = with gearing	SER	3	6	4	/	3	L	3	S	M	O	T	O	IP41	2	3	K	50	PTC
Temperature sensor PTC = PTC	SER	3	6	4	/	3	L	3	S	M	O	T	O	IP41	2	3	K	50	PTC

¹⁾ With mounting position IM V3 (drive shaft vertical, shaft end upward) only degree of protection IP 41 is guaranteed.

²⁾ Possible motor-gearing combinations see page 35f

SER 39•											
Technical data											
Motor type		SER 397		SER 3910		SER 3913			SER 3916		
Winding ¹⁾		3S	7S	3S	7S	3S	5S	7S	3S	5S	7S
Nominal supply voltage $U_N = 230 V_{AC}$											
• Nominal continuous torque M_N	Nm	0.6	0.8	1.6	1.8	2.1	2.5	2.6	1.9	2.3	2.8
• Nominal continuous current I_N	A_{rms}	1.5	1.0	2.1	1.4	2.9	2.1	1.2	2.5	2.3	1.8
• Nominal speed n_N	1/min	6000	3600	4000	2200	3800	2500	1200	4000	3000	1800
• Nominal power P_N	kW	0.38	0.30	0.67	0.42	0.84	0.65	0.33	0.80	0.72	0.53
Nominal supply voltage $U_N = 400 V_{AC}$											
• Nominal continuous torque M_N	Nm	0.6	0.6	1.1	1.5	1.7	2.0	2.5	1.1	1.6	2.2
• Nominal continuous current I_N	A_{rms}	1.5	0.7	1.8	1.2	2.5	1.8	1.1	1.7	1.9	1.5
• Nominal speed n_N	1/min	6000	6000	6000	4000	6000	4500	2300	6000	5000	3300
• Nominal power P_N	kW	0.38	0.38	0.69	0.63	1.06	0.94	0.60	0.69	0.84	0.76
Nominal supply voltage $U_N = 480 V_{AC}$											
• Nominal continuous torque M_N	Nm	0.6	0.6	1.1	1.3	1.7	1.8	2.4	1.1	1.1	2
• Nominal continuous current I_N	A_{rms}	1.5	0.7	1.8	1.1	2.5	1.6	1.1	1.7	1.1	1.2
• Nominal speed n_N	1/min	6000	6000	6000	4700	6000	5500	2600	6000	6000	3800
• Nominal power P_N	kW	0.38	0.38	0.69	0.64	1.06	1.04	0.65	0.69	0.69	0.80
Continuous torque M_0 ²⁾	Nm	1.1		2.2		2.9			3.6		
Continuous current I_0	A_{rms}	2.6	1.3	3.0	1.7	3.7	2.5	1.3	4.4	3.5	2.1
Voltage constant k_{EU_V} ³⁾	V_{rms}	27.5	50.7	47.2	83.2	49.5	72.3	141.6	51.5	65.0	103.6
Winding resistance R_W	Ω	3.7	13	5.4	13.7	3.3	7.5	27.5	2.65	4.2	10.4
Winding inductance L_{qU_V}	mH	13.6	47.9	20.3	60.7	14.1	30.3	115	10.2	18.6	51.8
Winding inductance L_{dU_V}	mH	11.7	40.9	17.6	51.5	12.2	26.1	98.6	8.4	15.8	41.4
Maximum values											
Max. winding voltage U_{max}	V_{AC}	480		480		480			480		
	V_{DC}	680		680		680			680		
Max. voltage against PE	V_{AC}	300		300		300			300		
Max. current I_{max} ⁴⁾	A_{rms}	10.4	5.2	12.0	6.8	14.8	10.0	5.2	17.6	14.0	8.4
Max. torque M_{max}	Nm	3.43	3.56	6.69	6.78	9.51	9.51	9.51	12.67	11.81	12.38
Max. allowable speed of rotation n_{max}	1/min	6000		6000		6000			6000		
Max. continuous power P_{dmax}	kW	0.38		0.69		1.06			0.85		
Torque at max. continuous power M_{Pdmax}	Nm	0.6		1.1		1.7			1.8		
Speed of rotation at max. continuous power n_{Pdmax}	1/min	6000		6000		6000			4500		
Mechanical values											
Rotor moment of inertia J_R	kgcm ²	0.85		1.6		2.4			3.2		
Mass m ⁵⁾	kg	2.2		3.3		4.4			6.1		
Shaft load ⁶⁾											
• Max. radial force front F_R	N	- 10% ED		520		500			500		
		- 100% ED		450		430			450		
• Max. axial force tension/compression F_A	N	- 10% ED		520		520			520		
		- 100% ED		450		450			450		
• Nominal bearing lifetime L_{10h}	h	20000		20000		20000			20000		

1) Definition of winding see type code

2) At 20 1/min; for $n = 0$ max. 89%

3) RMS value at 1000 1/min

4) Max. 2.5 s

5) Without holding brake

6) Axial and radial forces must not occur simultaneously

Characteristic curves

SER 397 / 4L 3S

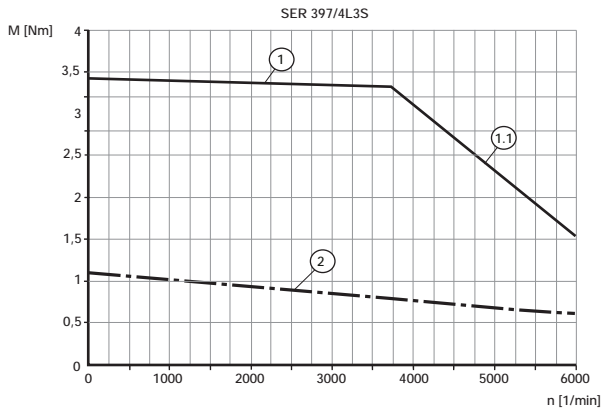

SER 397 / 4L 7S

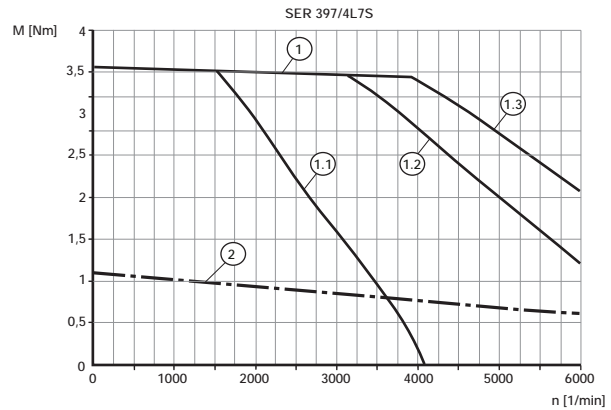

SER 3910 / 4L 3S

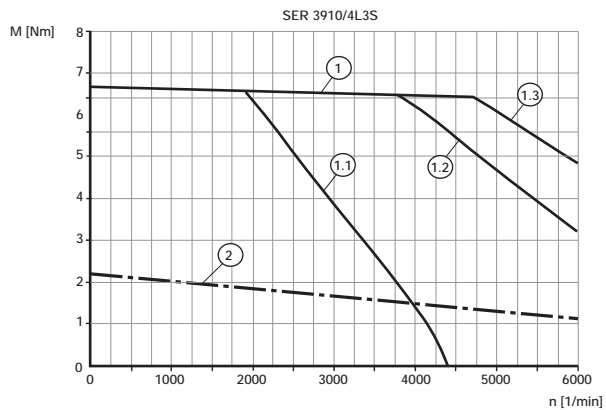

SER 3910 / 4L 7S

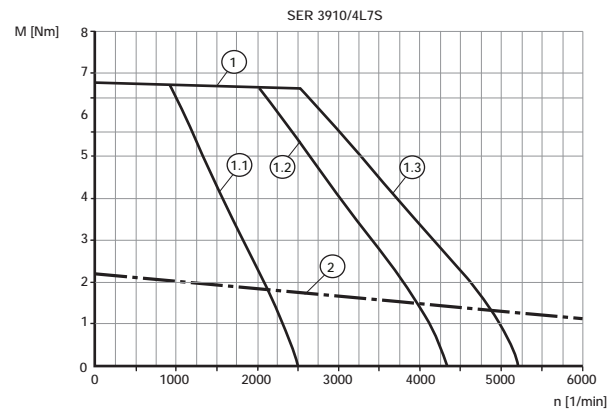

- (1) Peak torque of motor
- (1.1) Speed limit at $230 V_{eff}$
- (1.2) Speed limit at $400 V_{eff}$
- (1.3) Speed limit at $480 V_{eff}$
- (2) Continuous torque of motor

Note: The peak torque characteristics show the maximum values of the motors. The peak characteristics of the motors in combination with servo drive systems can be found at: www.berger-lahr.de > Downloads > Documentations > Motors.

Characteristic curves

SER 3913 / 4L 3S

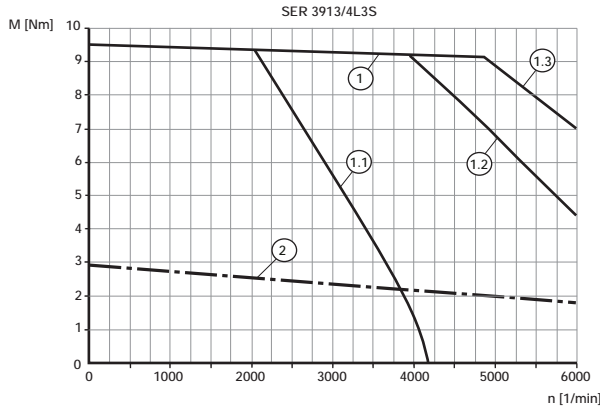

SER 3913 / 4L 5S

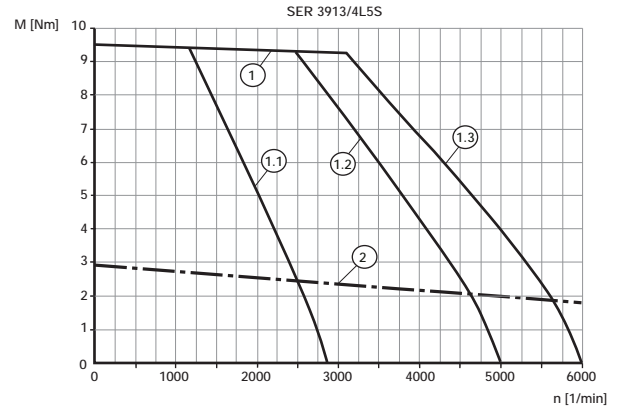

SER 3913 / 4L 7S

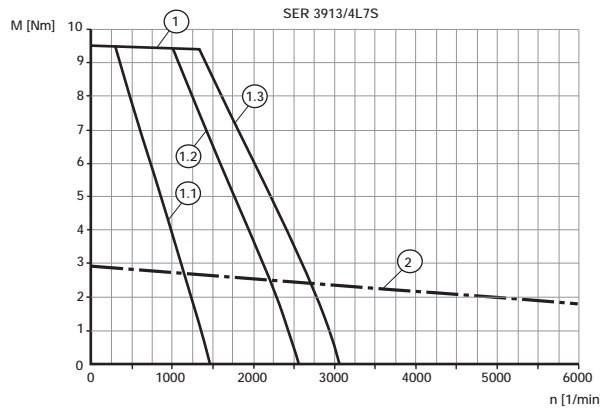

SER 3916 / 4L 3S

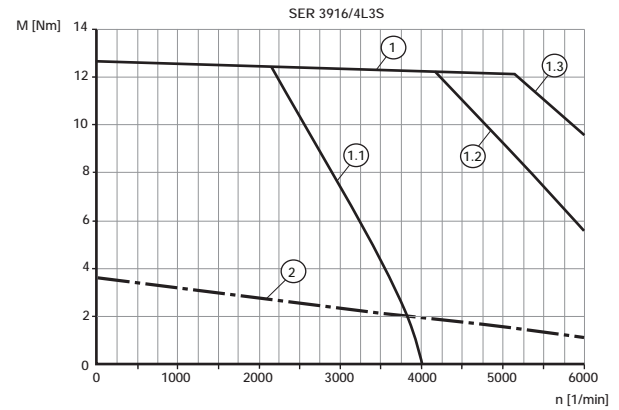

SER 3916 / 4L 5S

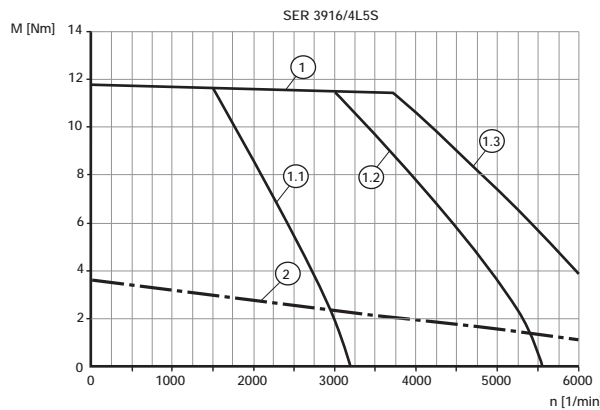

SER 3916 / 4L 7S

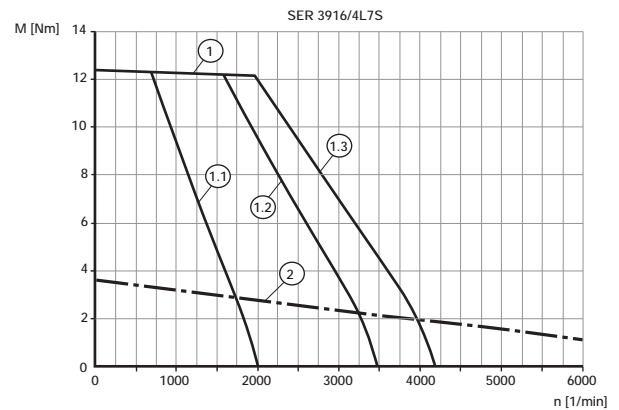

- (1) Peak torque of motor
- (1.1) Speed limit at 230 V_{eff}
- (1.2) Speed limit at 400 V_{eff}
- (1.3) Speed limit at 480 V_{eff}
- (2) Continuous torque of motor

Note: The peak torque characteristics show the maximum values of the motors. The peak characteristics of the motors in combination with servo drive systems can be found at: www.berger-lahr.de > Downloads > Documentations > Motors.

Ambient conditions

Operating / ambient temperature without power reduction	°C	20 ... 40
Installation height without power reduction	m above MSL	1000
Transport and storage temperature	°C	-25 ... +70
Relative humidity	%	15 ... 85 (non-condensing)
Vibration magnitude in operation as per DIN EN 60034-14		A
Vibration strain as per DIN EN 60068-2-6		
• Acceleration amplitude	m/s ²	20
• Frequency range	Hz	10 ... 500
• Number of cycles		10
Degree of protection as per DIN EN 60034-5		
• Shaft exit front without shaft seal ring		IP 41
• Shaft exit front with shaft seal ring		IP 56 ¹⁾
• Motor housing		IP 56
Thermal class as per DIN EN 60034-1		155 (F)
Shaft wobble and run-out accuracy		as per DIN 42955 N (IEC 60072-1)
Max. rotary acceleration	rad/s ²	200000

¹⁾ With mounting position IM V3 (drive shaft vertical, shaft end upward) only degree of protection IP 41 is guaranteed.

Dimensional drawings

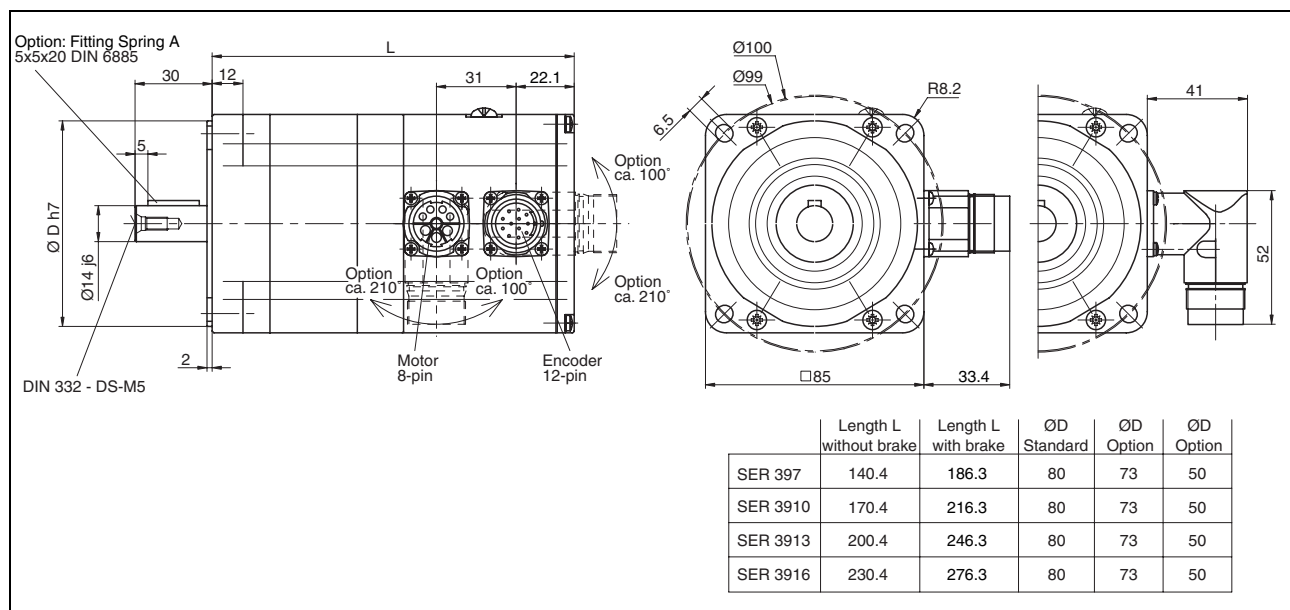

Dimensional drawing of SER 39•

Type code																		
Example:	SER	3	9	7	/	4	L	3	S	M	O	T	O	IP41	3	3	K 80	PTC
Number of phases 3	SER	3	9	7	/	4	L	3	S	M	O	T	O	IP41	3	3	K 80	PTC
Size (flange) 9 = 85 mm	SER	3	9	7	/	4	L	3	S	M	O	T	O	IP41	3	3	K 80	PTC
Length 7 = 141 mm 10 = 171 mm 13 = 201 mm 16 = 231 mm	SER	3	9	7	/	4	L	3	S	M	O	T	O	IP41	3	3	K 80	PTC
Number of pole pairs 4	SER	3	9	7	/	4	L	3	S	M	O	T	O	IP41	3	3	K 80	PTC
Rotor inertia L = low moment of inertia	SER	3	9	7	/	4	L	3	S	M	O	T	O	IP41	3	3	K 80	PTC
Winding label 3; 5; 7	SER	3	9	7	/	4	L	3	S	M	O	T	O	IP41	3	3	K 80	PTC
Winding circuit S = star	SER	3	9	7	/	4	L	3	S	M	O	T	O	IP41	3	3	K 80	PTC
Sensor system S = SinCos Singleturn M = SinCos Multiturn R = resolver	SER	3	9	7	/	4	L	3	S	M	O	T	O	IP41	3	3	K 80	PTC
Sensor system resolution O for sensor systems S, M, R	SER	3	9	7	/	4	L	3	S	M	O	T	O	IP41	3	3	K 80	PTC
Plug connector C = straight T = 90° angled	SER	3	9	7	/	4	L	3	S	M	O	T	O	IP41	3	3	K 80	PTC
Holding brake O = without brake B = with brake	SER	3	9	7	/	4	L	3	S	M	O	T	O	IP41	3	3	K 80	PTC
Degree of protection IP41 = without shaft seal ring IP56 = with shaft seal ring ¹⁾	SER	3	9	7	/	4	L	3	S	M	O	T	O	IP41	3	3	K 80	PTC
Gearbox type ²⁾ 3 = PLE 80 4 = PLE 120 A = PLS 70 B = PLS 90 C = PLS 115	SER	3	9	7	/	4	L	3	S	M	O	T	O	IP41	3	3	K 80	PTC
Gear ratio 3 = 3:1 5 = 5:1 8 = 8:1	SER	3	9	7	/	4	L	3	S	M	O	T	O	IP41	3	3	K 80	PTC
Motor shaft model K = parallel key DIN 6885 O = without parallel key / without gearing	SER	3	9	7	/	4	L	3	S	M	O	T	O	IP41	3	3	K 80	PTC
Centring collar OO = with gearing 50 = 50 mm 73 = 73 mm 80 = 80 mm	SER	3	9	7	/	4	L	3	S	M	O	T	O	IP41	3	3	K 80	PTC
Temperature sensor PTC = PTC	SER	3	9	7	/	4	L	3	S	M	O	T	O	IP41	3	3	K 80	PTC

¹⁾ With mounting position IM V3 (drive shaft vertical, shaft end upward) only degree of protection IP 41 is guaranteed.

²⁾ Possible motor-gearing combinations see page 35f

SER 311•

Technical data

Motor type		SER 31112			SER 31117			SER 31122		SER 31127	
Winding ¹⁾		3S	5S	7S	3S	5S	7S	5S	7S	5D	7S
Nominal supply voltage $U_N = 230 V_{AC}$											
• Nominal continuous torque M_N	Nm	2.5	3.3	4.0	3.6	4.2	5.5	4.5	8.2	8.5	10.8
• Nominal continuous current I_N	A_{rms}	3.5	2.8	1.7	3.8	3.3	2.3	3.0	3.0	6.0	4.2
• Nominal speed n_N	1/min	4000	2200	1000	3300	2400	1250	2250	1000	2200	1100
• Nominal power P_N	kW	1.05	0.76	0.42	1.24	1.06	0.72	1.06	0.86	1.96	1.25
Nominal supply voltage $U_N = 400 V_{AC}$											
• Nominal continuous torque M_N	Nm	1.5	2.5	3.4	1.5	3.3	4.6	5.0	7.5	4.5	9.0
• Nominal continuous current I_N	A_{rms}	2.1	2.1	1.5	1.7	2.6	2.0	3.5	2.8	3.2	3.7
• Nominal speed n_N	1/min	6000	4000	2000	6000	4000	2250	4000	2000	4000	2000
• Nominal power P_N	kW	0.94	1.05	0.71	0.94	1.38	1.05	2.09	1.57	1.88	1.88
Nominal supply voltage $U_N = 480 V_{AC}$											
• Nominal continuous torque M_N	Nm	1.5	2.0	3.2	1.5	2.6	4.5	4.6	7.2	3.4	7.8
• Nominal continuous current I_N	A_{rms}	2.1	1.7	1.4	1.7	2.1	1.9	3.3	2.6	2.3	3.1
• Nominal speed n_N	1/min	6000	5000	2400	6000	4900	2500	4300	2250	4500	2500
• Nominal power P_N	kW	0.94	1.05	0.80	0.94	1.33	1.18	2.07	1.70	1.60	2.04
Continuous torque M_0 ²⁾	Nm	4.2			6.6			10		13.4	
Continuous current I_0	A_{rms}	6.0	3.6	1.8	6.6	5.0	2.7	7.0	3.6	9.2	5.1
Voltage constant k_{EU_V} ³⁾	V_{rms}	43.3	70.7	140.0	58.4	82.0	148.4	90.9	176	88.2	160
Winding resistance R_W	Ω	1.5	4	18.1	1.2	2.3	7.4	1.7	5.7	1.3	3.75
Winding inductance L_{dU_V}	mH	12.6	34.1	141	11.3	21.2	70.2	17.2	62.5	14.5	41.5
Winding inductance L_{dU_V}	mH	9.7	26.6	107	8.3	15.4	51.8	12.4	45.7	10.9	29.9
Maximum values											
Max. winding voltage U_{max}	V_{AC}	480			480			480		480	
	V_{DC}	680			680			680		680	
Max. voltage against PE	V_{AC}	300			300			300		300	
Max. current I_{max} ⁴⁾	A_{rms}	24.0	14.4	7.2	26.4	20.0	10.8	28.0	14.4	36.8	20.4
Max. torque M_{max}	Nm	11.76	11.93	11.93	20.86	20.06	20.33	30.00	30.00	39.13	40.20
Max. allowable speed of rotation n_{max}	1/min	6000			6000			4500		4500	
Max. continuous power P_{dmax}	kW	1.03			1.38			2.09		2.25	
Torque at max. continuous power M_{Pdmax}	Nm	2.1			3.3			5.0		6.7	
Speed of rotation at max. continuous power n_{Pdmax}	1/min	4700			4000			4000		3200	
Mechanical data											
Rotor moment of inertia J_R	kgcm ²	4			8			11.6		15.5	
Mass m	kg	5.0			8.0			11.0		13.0	
Shaft load ⁵⁾											
• Max. radial force front F_R											
- 10% ED	N	1480			1550			1530		760	
- 100% ED	N	690			800			800		760	
• Max. axial force tension/compression F_A											
- 10% ED	N	900			900			900		900	
- 100% ED	N	600			600			600		600	
• Nominal bearing lifetime L_{10h}	h	20000			20000			20000		20000	

¹⁾ Definition of winding see type code

²⁾ At 20 1/min; for $n = 0$ max. 89%

³⁾ RMS value at 1000 1/min

⁴⁾ Max. 2.5 s

⁵⁾ Axial and radial forces must not occur simultaneously

Characteristic curves

SER 31112 / 4L 3S

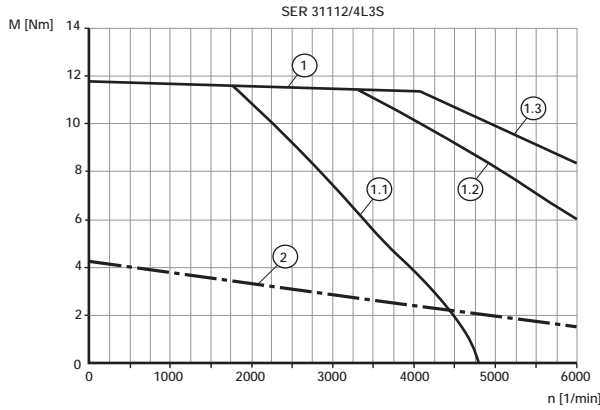

SER 31112 / 4L 5S

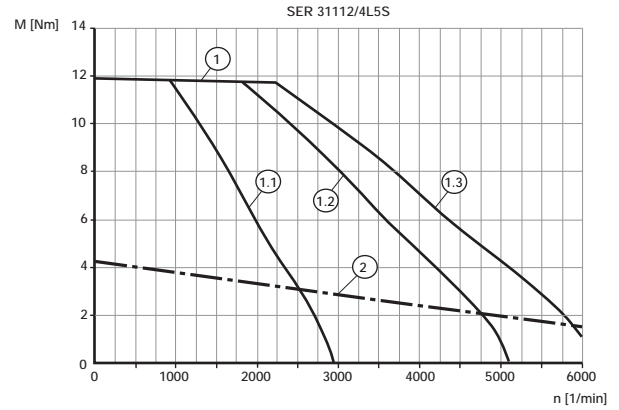

SER 31112 / 4L 7S

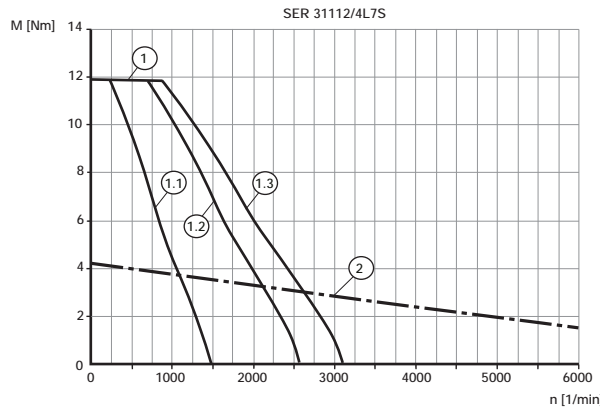

SER 31117 / 4L 3S

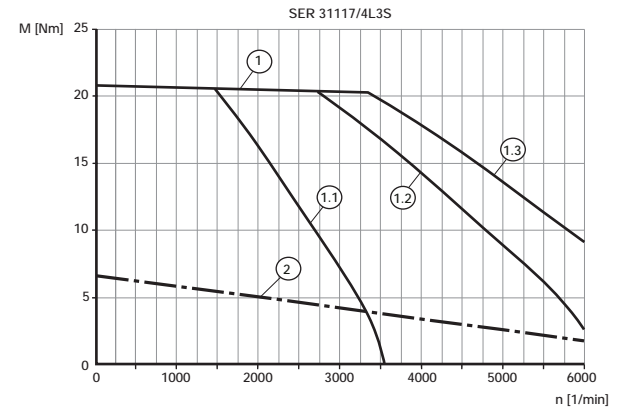

SER 31117 / 4L 5S

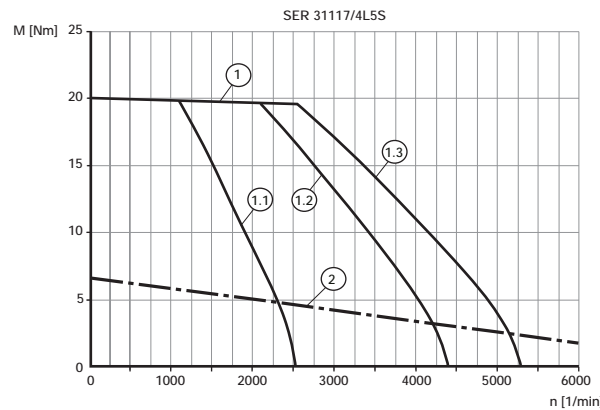

SER 31117 / 4L 7S

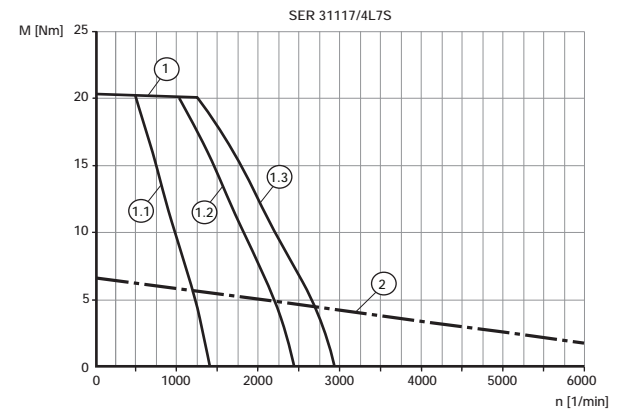

- (1) Peak torque of motor
- (1.1) Speed limit at 230 V_{eff}
- (1.2) Speed limit at 400 V_{eff}
- (1.3) Speed limit at 480 V_{eff}
- (2) Continuous torque of motor

Note: The peak torque characteristics show the maximum values of the motors. The peak characteristics of the motors in combination with servo drive systems can be found at: www.berger-lahr.de > Downloads > Documentations > Motors.

Characteristic curves

SER 31122 / 4L 5S

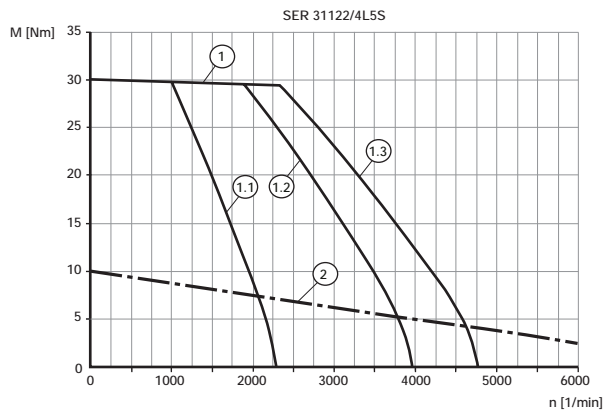

SER 31122 / 4L 7S

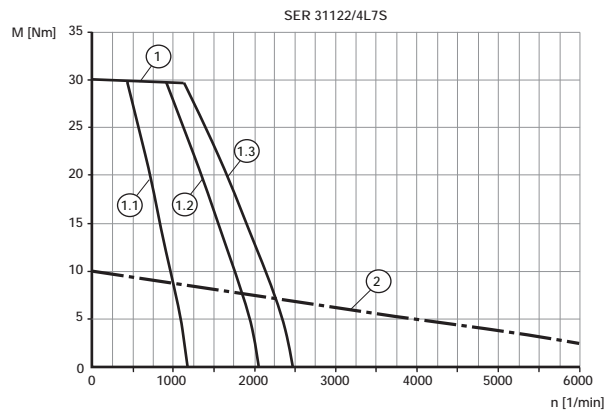

SER 31127 / 4L 5D

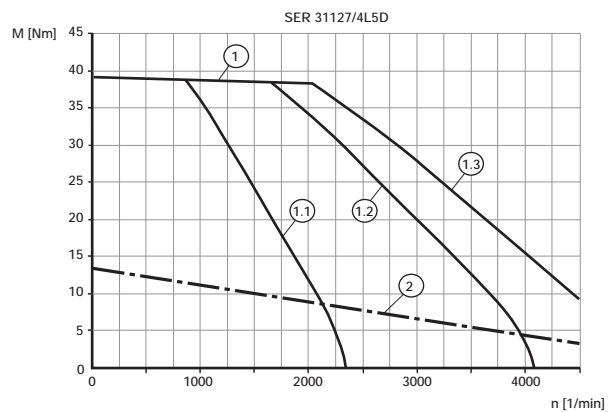

SER 31127 / 4L 7S

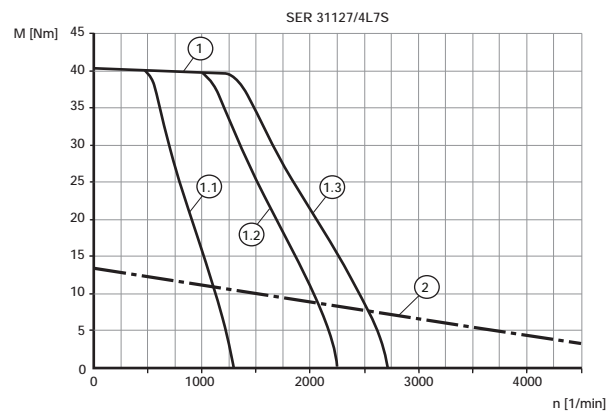

- (1) Peak torque of motor
- (1.1) Speed limit at 230 V_{eff}
- (1.2) Speed limit at 400 V_{eff}
- (1.3) Speed limit at 480 V_{eff}
- (2) Continuous torque of motor

Note: The peak torque characteristics show the maximum values of the motors. The peak characteristics of the motors in combination with servo drive systems can be found at: www.berger-lahr.de > Downloads > Documentations > Motors.

Ambient conditions

Operating / ambient temperature without power reduction	°C	20 ... 40
Installation height without power reduction	m above MSL	1000
Transport and storage temperature	°C	-25 ... +70
Relative humidity	%	15 ... 85 (non-condensing)
Vibration magnitude in operation as per DIN EN 60034-14		A
Vibration strain as per DIN EN 60068-2-6		
• Acceleration amplitude	m/s ²	20
• Frequency range	Hz	10 ... 500
• Number of cycles		10
Degree of protection as per DIN EN 60034-5		
• Shaft exit front without shaft seal ring		IP 41
• Shaft exit front with shaft seal ring		IP 56 ¹⁾
• Motor housing		IP 56
Thermal class as per DIN EN 60034-1		155 (F)
Shaft wobble and run-out accuracy		as per DIN 42955 N (IEC 60072-1)
Max. rotary acceleration	rad/s ²	200000

¹⁾ With mounting position IM V3 (drive shaft vertical, shaft end upward) only degree of protection IP 41 is guaranteed.

Dimensional drawings

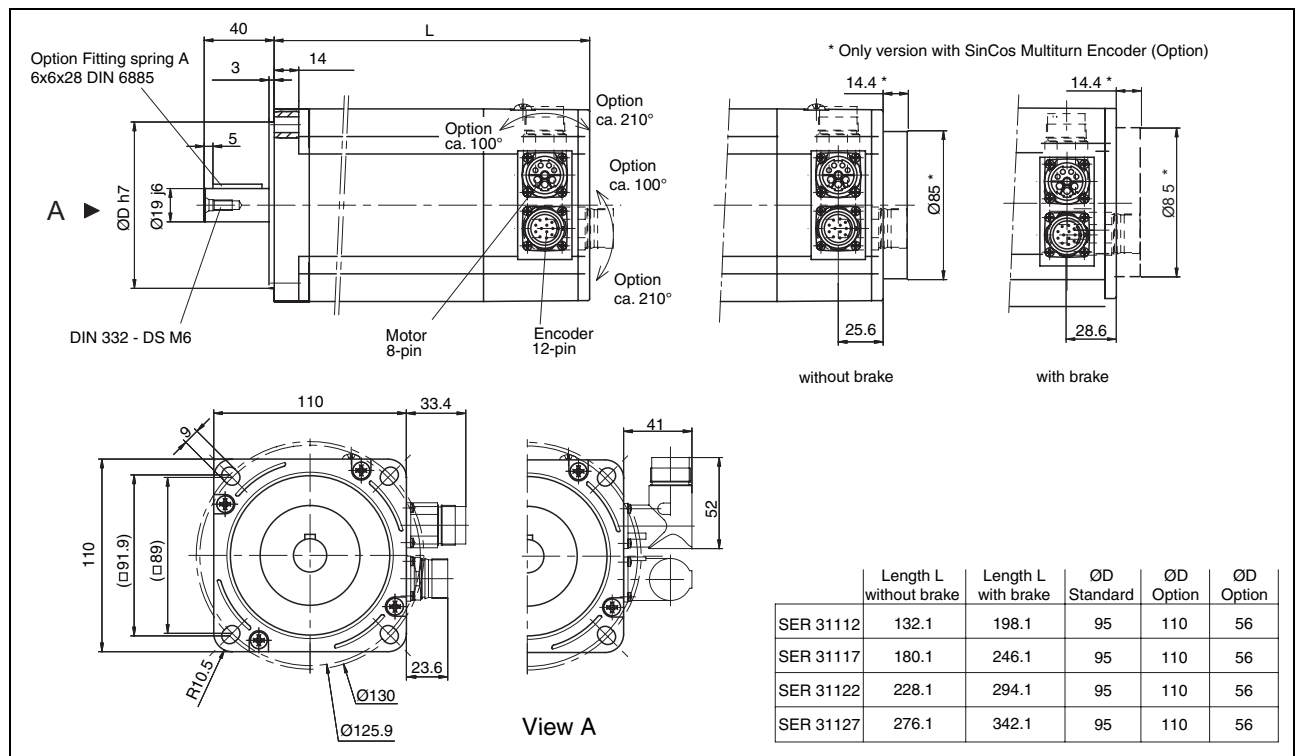

Dimensional drawing of SER 311•

Type code																			
Example:	SER	3	11	12	/	4	L	3	S	M	O	T	O	IP41	3	3	K	95	PTC
Number of phases 3	SER	3	11	12	/	4	L	3	S	M	O	T	O	IP41	3	3	K	95	PTC
Size (flange) 11 = 110 mm	SER	3	11	12	/	4	L	3	S	M	O	T	O	IP41	3	3	K	95	PTC
Length 12 = 132 mm 17 = 180 mm 22 = 228 mm 27 = 276 mm	SER	3	11	12	/	4	L	3	S	M	O	T	O	IP41	3	3	K	95	PTC
Number of pole pairs 4	SER	3	11	12	/	4	L	3	S	M	O	T	O	IP41	3	3	K	95	PTC
Rotor inertia L = low moment of inertia	SER	3	11	12	/	4	L	3	S	M	O	T	O	IP41	3	3	K	95	PTC
Winding label 3; 5; 7	SER	3	11	12	/	4	L	3	S	M	O	T	O	IP41	3	3	K	95	PTC
Winding circuit S = star	SER	3	11	12	/	4	L	3	S	M	O	T	O	IP41	3	3	K	95	PTC
Sensor system S = SinCos Singleturn M = SinCos Multiturn R = resolver	SER	3	11	12	/	4	L	3	S	M	O	T	O	IP41	3	3	K	95	PTC
Sensor system resolution O for sensor systems S, M, R	SER	3	11	12	/	4	L	3	S	M	O	T	O	IP41	3	3	K	95	PTC
Plug connector C = straight T = 90° angled	SER	3	11	12	/	4	L	3	S	M	O	T	O	IP41	3	3	K	95	PTC
Holding brake O = without brake B = with brake	SER	3	11	12	/	4	L	3	S	M	O	T	O	IP41	3	3	K	95	PTC
Degree of protection IP41 = without shaft seal ring IP56 = with shaft seal ring ¹⁾	SER	3	11	12	/	4	L	3	S	M	O	T	O	IP41	3	3	K	95	PTC
Gearbox type ²⁾ 3 = PLE 80 4 = PLE 120 B = PLS 90 C = PLS 115 D = PLS 142	SER	3	11	12	/	4	L	3	S	M	O	T	O	IP41	3	3	K	95	PTC
Gear ratio 3 = 3:1 5 = 5:1 8 = 8:1	SER	3	11	12	/	4	L	3	S	M	O	T	O	IP41	3	3	K	95	PTC
Motor shaft model K = parallel key DIN 6885 O = without parallel key / without gearing	SER	3	11	12	/	4	L	3	S	M	O	T	O	IP41	3	3	K	95	PTC
Centring collar OO = with gearing 11 = 110 mm 56 = 56 mm 95 = 95 mm	SER	3	11	12	/	4	L	3	S	M	O	T	O	IP41	3	3	K	95	PTC
Temperature sensor PTC = PTC	SER	3	11	12	/	4	L	3	S	M	O	T	O	IP41	3	3	K	95	PTC

¹⁾ With mounting position IM V3 (drive shaft vertical, shaft end upward) only degree of protection IP 41 is guaranteed.

²⁾ Possible motor-gearing combinations see page 35f

Options

Holding brake

The holding brake is an electromagnetic sprung brake. It holds the motor axis after the motor current is switched off, including after power failure and emergency stop. A holding brake is required particularly for torque loads caused by weight forces, such as occur with vertical axes used in handling applications.

Control

A motor with a holding brake requires appropriate control logic which releases the brake exactly at the start of a rotary movement and fixes the motor axis when the motor stops.

Control circuit

Use a suitable holding brake controller, such as the Berger Lahr TL HBC VW3M3103. The current of the brake voltage must be reduced after about 100 ms, because otherwise the specified torque characteristics will not be guaranteed because of the additional heat build-up. The holding brake controller should have secure electrical isolation for the brake power supply and comply with the EMC Standard DIN EN 618008-3.

Technical Data

Motor		SER 36•	SER 39•	SER 311•
Nominal voltage	V_{DC}	$24 \pm 10\%$	$24 \pm 10\%$	$24 \pm 10\%$
Holding torque	Nm	1.2	6	16
Electrical pull-in power	W	10	24	28
Moment of inertia	$kgcm^2$	0.07	0.2	0.35
Energise time (release brake)	ms	14	40	60
De-energise time (apply brake)	ms	13	20	30
Mass	kg	Approx. 0.3	Approx. 1.8	Approx. 3.0

Motor connection

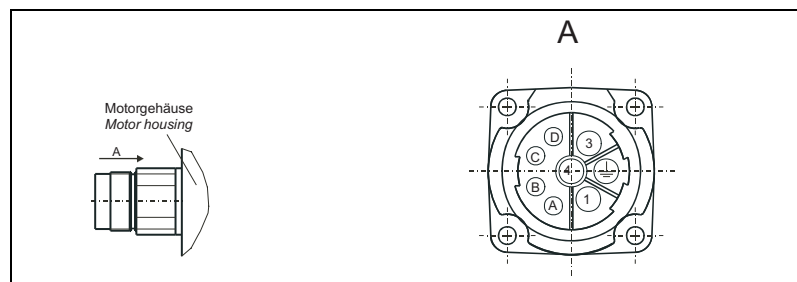

Motor connection

Manufacturer: Intercontec,
power plug connector 8-pin, BEGA089NN0000 0002 000

PIN	Assignments
1	U
2	PE
3	W
4	V
A	Holding brake +
B	Holding brake -
C	not connected
D	not connected

Position capture

SinCos encoder

SinCos (SRS50) Singleturn

The "SinCos (SRS50) Singleturn" sensor system measures an absolute value within one revolution after being switched on and continues to count incrementally from this point.

Technical Data

Resolution		depends on controller
Measurement range absolute		1 revolution
Error limit of digital absolute value	arcmin	± 1.5 (depending on controller)
Precision of the incremental position evaluation	arcmin	± 0.75
Signal shape		sinus
Supply voltage	V	7 ... 12 (recommended 8 V)
Current consumption	mA	80 (without load)

For more information see www.stegmann.de

SinCos (SRSM50) Multiturn

The "SinCos (SRM50) Multiturn" sensor system measures an absolute value within 4096 revolutions after being switched on and continues to count incrementally from this point.

Technical Data

Resolution		depends on controller
Measurement range absolute		4096 revolution
Error limit of digital absolute value	arcmin	± 1.5 (depending on controller)
Precision of the incremental position evaluation	arcmin	± 0.75
Signal shape		sinus
Supply voltage	V	7 ... 12 (recommended 8 V)
Current consumption	mA	80 (without load)

For more information see www.stegmann.de

SinCos encoder sensor connection

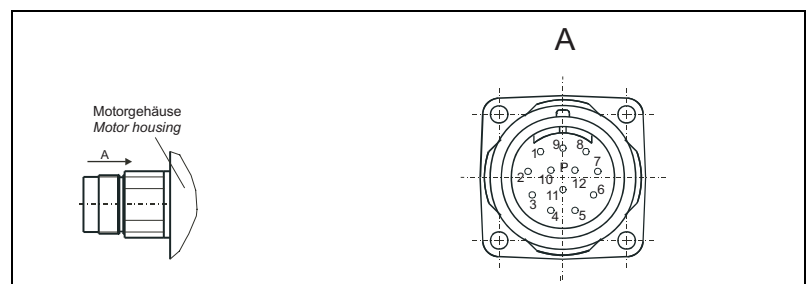

SinCos Encoder sensor connector (Singleturn and Multiturn)

Manufacturer: Intercontec,

signal plug connector 12-pin, AEGA052NN0000 1250 000

PIN	Assignments
1	Temperature sensor PTC
2	Temperature sensor PTC
3	not connected
4	REF SIN
5	REF COS
6	Data+ RS 485
7	Data- RS 485
8	+ SIN
9	+ COS
10	U_s 7-12 V
11	GND
12	not connected

PTC: S+M, Model B59135-M155-A7

Resolver

The "resolver" sensor system is a very robust system. Absolute position capture is possible within one revolution.

Technical Data

Resolution		depends on controller
Measurement range absolute		1 revolution
Precision of the incremental position evaluation	arcmin	±6
Input voltage	V_{eff}	7
Current consumption	mA	38

Resolver sensor connection

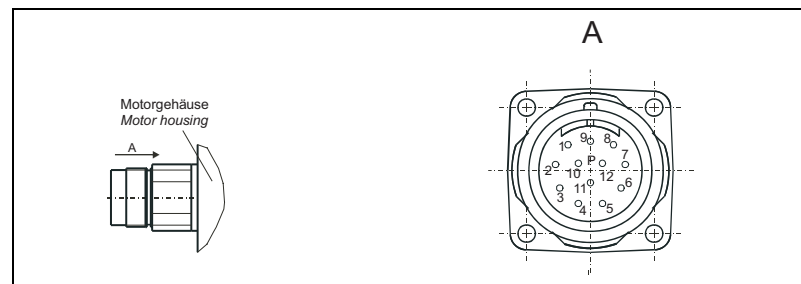

Sensor plug resolver

Manufacturer: Intercontec,
signal plug connector 12-pole, AEGA052NN0000 1250 000

PIN	Assignments
1	Temperature sensor PTC
2	Temperature sensor PTC
3	not connected
4	- SIN
5	- COS
6	REF +
7	REF -
8	+ SIN
9	+ COS
10	not connected
11	not connected
12	not connected

PTC: S+M, Model B59135-M155-A70



Gearing for SER servomotors

Stepper motors from Berger Lahr can also be fitted with integrated planetary gear. The PLE gearing comprises economical planetary gears that meet most requirements for accuracy. The PLS gearing is high-quality gearing with very low rotation play. This gearing can be supplied with one of three ratios: 3:1, 5:1 and 8:1. The output torque of the gearing is determined by multiplying the torque of the motor with the gear ratio and the efficiency of the gearing.

PLE gearing

The following table shows the preferred motor-gearing combinations.

Motor type	PLE gearing		
	3:1	5:1	8:1
SER 364 / 366	PLE 60	PLE 60	PLE 60
SER 368 / 3610	PLE 60	PLE 60	PLE 60 ¹⁾
SER 397	PLE 80	PLE 80	PLE 80
SER 3910	PLE 80	PLE 80	PLE 120
SER 3913	PLE 80	PLE 80	PLE 120
SER 3916	PLE 120	PLE 120	PLE 120
SER 31112	PLE 120	PLE 120	PLE 120
SER 31117	PLE 120	PLE 120	PLE 160
SER 31122	PLE 160	PLE 160	PLE 160
SER 31127	PLE 160	PLE 160	PLE 160

¹⁾ The continuous gearing output torque must not be continuously exceeded. Twice the torque is possible for a short time, such as in an emergency stop situation. It may be necessary to limit the motor, otherwise the gearing may be destroyed at peak torques.

Technical Data

PLE gearing general

Gear stages		1
Life time ¹⁾	h	10000
Efficiency at full load	%	96
Housing material		aluminium
Surface		black anodised
Shaft material		C 45
Bearings		roller bearing
Operating temperature ²⁾	°C	-25 ... +90, shortly +120
Degree of protection ³⁾		IP 54
Lubrication		life lubrication

¹⁾ Life time with an output speed of 100 1/min and T = 30 °C

²⁾ Referring to the housing surface

³⁾ With mounting position IM V3 (drive shaft vertical, shaft end upward) only degree of protection IP 41 is guaranteed

Size of PLE		60	80	120	160
Max. radial force ^{1) 2)}	N	500	950	2000	6000
Max. axial force ¹⁾	N	600	1200	2800	8000
Torsional play	arcmin	< 20	< 12	< 8	< 6
Max. drive speed	1/min	13000	7000	6500	6500
Recommended drive speed	1/min	4000	4000	3500	3000
Torsional stiffness	Nm/arcmin	2.3	6	12	38
Weight	kg	0.9	2.1	6.0	18

¹⁾ The information refers to min. 20000 h life time with an output speed of 100 1/min and application factor K = 100 min and S1 operating mode for electrical machines and T = 30 °C

²⁾ Refers to the centre of the driven shaft and 50% ED

PLS gearing

The following table shows the recommended motor-gearing combinations.

Motor type	PLS gearing		
	3:1	5:1	8:1
SER 36•	PLS 70	PLS 70	PLS 70
SER 397	PLS 70	PLS 70	PLS 70
SER 3910	PLS 70	PLS 70	PLS 90
SER 3913	PLS 70	PLS 90	PLS 115
SER 3916	PLS 90	PLS 90	PLS 115
SER 31112	PLS 90	PLS 90	PLS 115
SER 31117	PLS 90	PLS 115	PLS 142
SER 31122	PLS 115	PLS 115	PLS 142
SER 31127	PLS 115	PLS 142	PLS 142

Technical Data

PLS gearing general

Gear stages		1
Life time ¹⁾	h	20000
Efficiency at full load	%	98
Housing material		aluminium
Surface		black anodised
Shaft material		C 45
Bearings		tapered roller bearings
Operating temperature ²⁾	°C	-25 ... +100, shortly +124
Degree of protection ³⁾		IP 65
Lubrication		life lubrication

¹⁾ Life time with an output speed of 100 1/min and T = 30 °C

²⁾ Referring to the housing surface

³⁾ With mounting position IM V3 (drive shaft vertical, shaft end upward) only protection class IP 41 is guaranteed

Size of PLS		70	90	115	142
Max. radial force ^{1) 2)}	N	3000	4000	5000	9000
Max. axial force ¹⁾	N	6000	9000	12000	15000
Torsional play	arcmin	<3	<3	<3	<3
Max. drive speed	1/min	14000	10000	8500	6500
Recommended drive speed	1/min	5000	4500	4000	3000
Torsional stiffness	Nm/arcmin	6	9	20	44
Weight	kg	3.0	4.3	9.0	15.4

¹⁾ The information refers to min. 20000 h life time with an output speed of 100 1/min and application factor K = 100 min and S1 operating mode for electrical machines and T = 30 °C

²⁾ Refers to the centre of the driven shaft and 50% ED

Dimensional drawings of PLE gearing

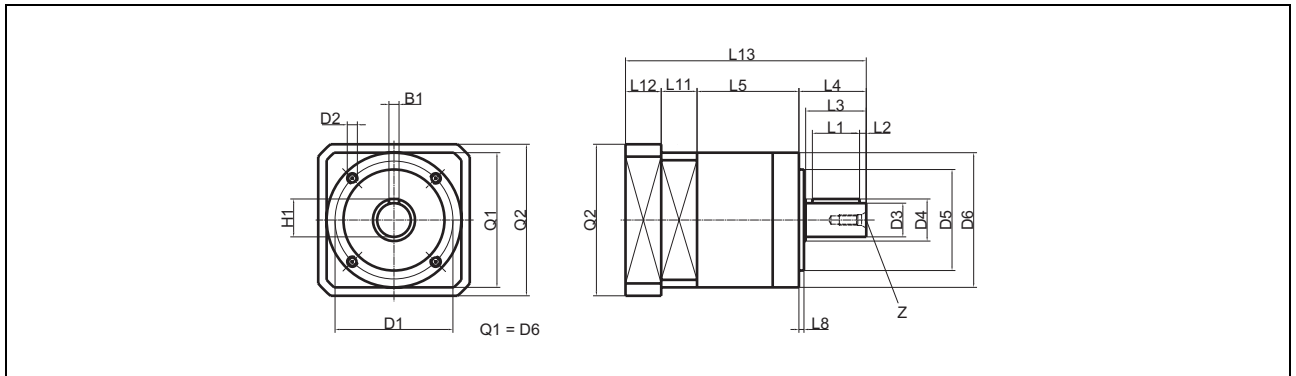

Size of PLE		60	80	120	160
Combination options		SER 36•	SER 39•	SER 39• SER 311•	SER 311•
Flange hole circle	D1	52	70	100	145
Screw-in thread	D2	M5*8	M6*10	M10*16	M12*20
Shaft diameter	D3	14	20	25	40
Shaft stub	D4	17	25	35	55
Centring	D5	40	60	80	130
Housing diameter	D6	60	80	115	160
Adapter flange cross section	Q2	60	90	115	140
Centre hole ¹⁾	Z	M5*12	M6*16	M10*22	M16*36
Parallel key height ²⁾	H1	16	22.5	28	43
Parallel key width ²⁾	B1	5	6	8	12
Parallel key length ²⁾	L1	25	28	40	65
Distance from shaft end	L2	2.5	4	5	8
Shaft length to collar	L3	30	36	50	80
Output shaft length	L4	35	40	55	87
Case length	L5	47	60.5	74	104
Output centring collar	L8	3	3	4	5
Intermediate flange length	L11	8.2	12	25.5	-
Adapter flange length	L12	16	21.2	21.8	64.5
Total length	L13	106.2	133.7	176.3	255.5

¹⁾ Centre hole DIN 332, page 2, form DS

²⁾ Parallel key DIN 6885 T1

Dimensional drawings of PLS gearing

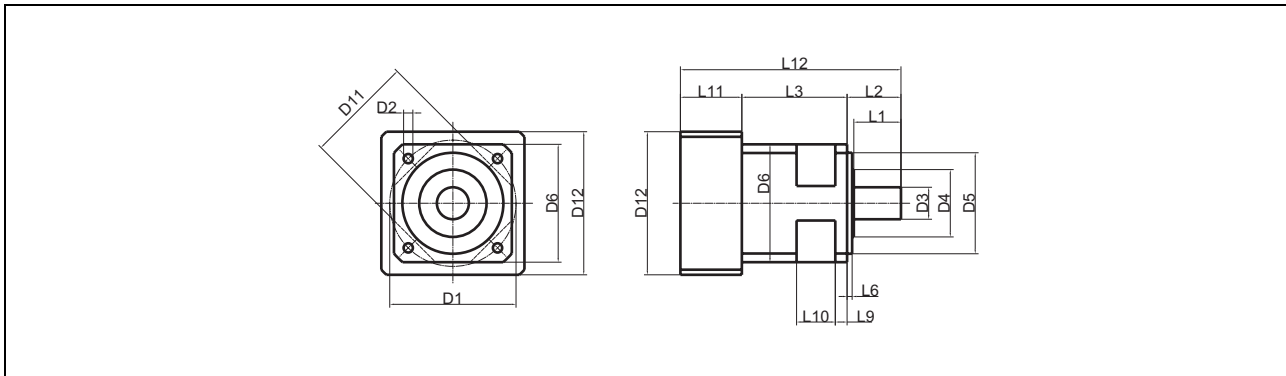

Size of PLS		70	70	90	90	115	142
Combination options		SER 36•	SER 39•	SER 39•	SER 311•	SER 39• SER 311•	SER 311•
Flange hole circle	D1	75	75	100	100	130	165
Screw-in hole	D2	5.5	5.5	6.5	6.5	8.5	11
Shaft diameter	D3	19	19	22	22	32	40
Shaft stub	D4	40	40	50	50	55	65
Centring	D5	60	60	80	80	110	130
Gearing cross section	D6	70	70	90	90	115	140
Cut-out	D11	64	64	87	87	115	140
Motor flange cross section	D12	70	90	90	115	115	140
Shaft length to collar	L1	28	28	36	36	58	80
Output shaft length	L2	32	32	41.5	41.5	64.5	87
Case length	L3	62.5	62.5	69	69	77.5	102
Output centring collar	L6	3	3	3	3	4	5
Flange thickness	L9	7	7	8	8	14	20
Cut-out width	L10	23	23	30	30	34	52
Motor flange length	L11	29.5	36.5	40	50	46	64.5
Total length	L12	124	131	150.5	160.5	188	253.5

All information refers to a single-stage gearing.

Conversion tables

Rotor inertia

	lb-in ²	lb-ft ²	lb-in-s ²	lb-ft-s ² slug-ft ²	kg-cm ²	kg-cm-s ²	g-cm ²	g-cm-s ²	oz-in ²	oz-in-s ²
lb-in ²	–	6.94 x 10 ⁻³	2.59 x 10 ⁻³	2.15 x 10 ⁻⁴	2.926	2.98 x 10 ⁻³	2.92 x 10 ³	2.984	16	4.14 x 10 ⁻²
lb-ft ²	144	–	0.3729	3.10 x 10 ⁻²	421.40	0.4297	4.21 x 10 ⁵	429.71	2304	5.967
lb-in-s ²	386.08	2.681	–	8.33 x 10 ⁻²	1.129 x 10 ³	1.152	1.129 x 10 ⁶	1.152 x 10 ³	6.177 x 10 ³	16
lb-ft-s ² slug-ft ²	4.63 x 10 ³	32.17	12	–	1.35 x 10 ⁴	13.825	1.355 x 10 ⁷	1.38 x 10 ⁴	7.41 x 10 ⁴	192
kg-cm ²	0.3417	2.37 x 10 ⁻³	8.85 x 10 ⁻⁴	7.37 x 10 ⁻⁶	–	1.019 x 10 ⁻³	1000	1.019	5.46	1.41 x 10 ⁻²
kg-cm-s ²	335.1	2.327	0.8679	7.23 x 10 ⁻²	980.66	–	9.8 x 10 ⁵	1000	5.36 x 10 ³	13.887
g-cm ²	3.417 x 10 ⁻⁴	2.37 x 10 ⁻⁶	8.85 x 10 ⁻⁷	7.37 x 10 ⁻⁸	1 x 10 ⁻³	1.01 x 10 ⁻⁶	–	1.01 x 10 ⁻³	5.46 x 10 ⁻³	1.41 x 10 ⁻⁶
g-cm-s ²	0.335	2.32 x 10 ⁻³	8.67 x 10 ⁻⁴	7.23 x 10 ⁻⁵	0.9806	1 x 10 ⁻³	980.6	–	5.36	1.38 x 10 ⁻²
oz-in ²	0.0625	4.3 x 10 ⁻⁴	1.61 x 10 ⁻⁶	1.34 x 10 ⁻⁶	0.182	1.86 x 10 ⁻⁴	182.9	0.186	–	2.59 x 10 ⁻³
oz-in-s ²	24.13	0.1675	6.25 x 10 ⁻²	5.20 x 10 ⁻³	70.615	7.20 x 10 ⁻²	7.06 x 10 ⁴	72	386.08	–

Torque

	lb-in	lb-ft	oz-in	Nm	kg-m	kg-cm	g-cm	dyne-cm
lb-in	–	8.333 x 10 ⁻²	16	0.113	1.152 x 10 ⁻²	1.152	1.152 x 10 ³	1.129 x 10 ⁶
lb-ft	12	–	192	1.355	0.138	13.825	1.382 x 10 ⁴	1.355 x 10 ⁷
oz-in	6.25 x 10 ⁻²	5.208 x 10 ⁻³	–	7.061 x 10 ⁻³	7.200 x 10 ⁻⁴	7.200 x 10 ⁻²	72.007	7.061 x 10 ⁴
Nm	8.850	0.737	141.612	–	0.102	10.197	1.019 x 10 ⁴	1 x 10 ⁷
kg-m	86.796	7.233	1.388 x 10 ³	9.806	–	100	1 x 10 ⁵	9.806 x 10 ⁷
kg-cm	0.8679	7.233 x 10 ⁻²	13.877	9.806 x 10 ⁻²	1 x 10 ⁻²	–	1000	9.806 x 10 ⁵
g-cm	8.679 x 10 ⁻⁴	7.233 x 10 ⁻⁵	1.388 x 10 ⁻²	9.806 x 10 ⁻⁵	1 x 10 ⁻⁵	1 x 10 ⁻³	–	980.665
dyne-cm	8.850 x 10 ⁻⁷	7.375 x 10 ⁻⁸	1.416 x 10 ⁻⁵	1 x 10 ⁻⁷	1.019 x 10 ⁻⁸	1.0197 x 10 ⁻⁶	1.019 x 10 ⁻⁶	–

Power

	H.P.	W
H.P.	–	745.7
W	1.31 x 10 ⁻³	–

Length

	in	ft	yd	m	cm	mm
in	–	0.0833	0.028	0.0254	2.54	25.4
ft	12	–	0.333	0.3048	30.48	304.8
yd	36	3	–	0.914	91.44	914.4
m	39.37	3.281	1.09	–	100	1000
cm	0.3937	0.03281	1.09 x 10 ⁻²	0.01	–	10
mm	0.03937	0.00328	1.09 x 10 ⁻³	0.001	0.1	–

Rotation

	1/min (rpm)	rad/sec	deg./sec
1/min (rpm)	–	0.105	6.0
rad/sec	9.55	–	57.30
deg./sec	0.167	1.745 x 10 ⁻²	–

Weight

	lb	oz	slug	kg	g
lb	–	16	0.0311	0.453592	453.592
oz	6.35 x 10 ⁻²	–	1.93 x 10 ⁻³	0.028349	28.35
slug	32.17	514.8	–	14.5939	1.459 x 10 ⁴
kg	2.20462	35.274	0.0685218	–	1000
g	2.205 x 10 ⁻³	3.527 x 10 ⁻³	6.852 x 10 ⁻⁵	0.001	–

Temperature

	°F	°C
°F	–	(9 - 32) · ⁵ / ₉
°C	9 #) ⁹ / ₅ + 32	–

Force

	lb	oz	gf	dyne	N
lb	–	16	453.592	4.448 x 10 ⁵	4.4482
oz	0.0625	–	28.35	2.780 x 10 ⁴	0.27801
gf	2.205 x 10 ⁻³	0.03527	–	980.665	N.A.
dyne	2.248 x 10 ⁻⁶	3.59 x 10 ⁻⁶	1.02 x 10 ⁻³	–	0.0001
N	0.22481	3.5967	N.A.	100,000	–

Example for conversion:

Conversion of a 10 inch length measurement into metres. Look for the entry “in” (= inch) in the “Length” table in the left column and the entry “m” (= metre) in the header. The table cell at the point of intersection of the column and the row will show the conversion factor: “0.0254”. Multiply 10 inches by 0.0254 and you will get the value in metres: 10 in x 0.0254 = 0.254 m.





Berger Lahr offers you the positioning and automation solutions you need, based on our technology and proven series of products. Our comprehensive engineering and consulting service is ready to support and advise you every step of the way.

Berger Lahr is a member company of the Schneider Electric Group. With its Merlin Gerlin, Square D and Telemecanique brands, Schneider Electric is one of the leading providers of electrical and automation-engineering solutions.

